



Offset mulcher of high range with agricultural rotor, for works in agricultural margins, Banks, highways, channels, roads and others clears of public works for tractors between 120-160 HP. It incorporates safety system with springs. Angulation +90° / -65° Rotor POLSER of 550 °

CHARACTERISTICS

- ▶ Non-wear steel-plate chassis, thickness 10 mm.
- ▶ Rotor POLSER of Ø 550 mm.
- ▶ External gearbox SERRAT.
- ▶ 4 XPC side belt transmission.
- ▶ Double transmission with a centre shaft and homocinetic knot on the second transmission.
- ▶ Supports of bearing rotor in steel.
- ▶ Height-adjustable rear roller Ø 210 mm.
- ▶ PTO 1.000 rpm.
- ▶ High speed and high strength bearings.
- ▶ Front protection curtain.
- ▶ Front skid shoes.
- ▶ Double bearing on rear roller.
- ▶ Angulation +90° / -50°.
- ▶ Hydraulic lateral offset mulcher.
- ▶ Safety valve.
- ▶ Model built under EC Normative.
- ▶ Safety indicators visible to personnel.



Centre shaft with homocinetic knot



Springs safety system



Angulation: +90°







-50°

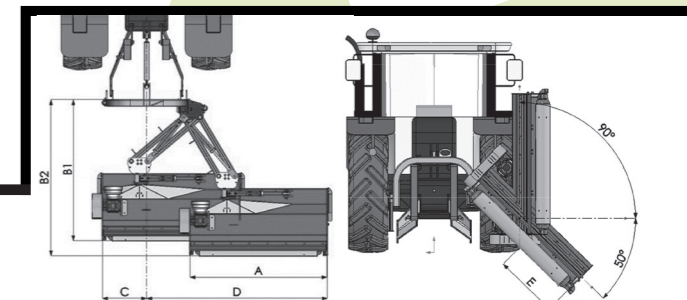
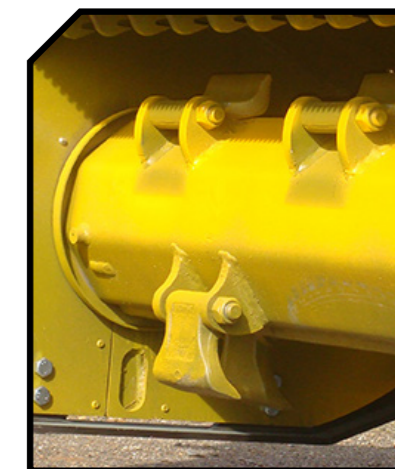

Agricultural hammers model SERRAT



MODEL	 mm	 KW-HP		 KG	Nº BELTS TYPE	A mm-in	B1 mm-in	B2 mm-in	C mm-in	D mm-in	E mm-in	
T-1800	1800	89 - 120 127 - 170	16	1655	4 XPC	1800 - 71"	2785 - 110"	2900 - 114"	190 - 7"	2825 - 111"	725 - 29"	1000
T-2000	2000	97 - 130 127 - 170	16	1710	4 XPC	2000 - 79"	2785 - 110"	2900 - 114"	190 - 7"	3025 - 119"	925 - 36"	1000
T-2300	2300	104 - 140 134 - 180	20	1790	4 XPC	2300 - 91"	2785 - 110"	2900 - 114"	190 - 7"	3325 - 131"	1225 - 48"	1000
T-2500	2500	112 - 150 134 - 180	20	1835	4 XPC	2500 - 98"	2785 - 110"	2900 - 114"	190 - 7"	3525 - 139"	1425 - 56"	1000

